

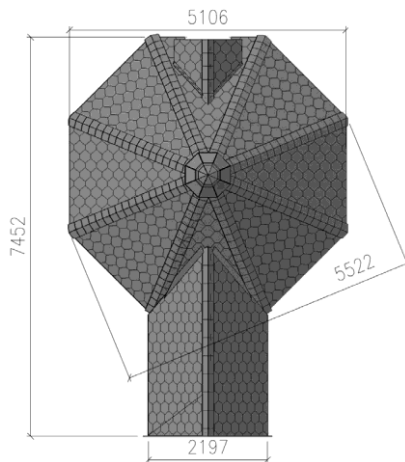

Hot Barrel

Grill Cabin 16.5 m<sup>2</sup>  
with Sauna Extension

health, beauty, peace of mind

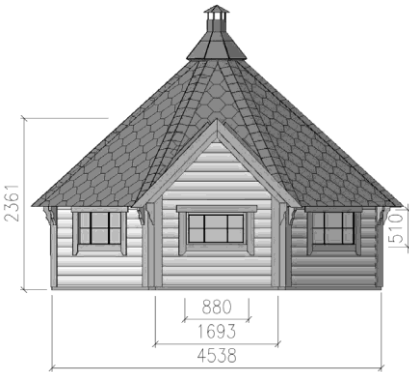
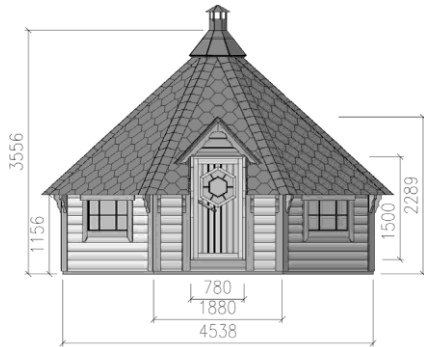
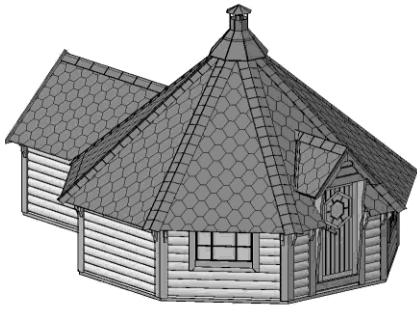

# Specifications

<b>Wood</b>	Spruce
<b>Shape</b>	8 corners + rectangle
<b>Inside area, m<sup>2</sup></b>	16.5 + 4.3
<b>Total height, m</b>	3.56
<b>Diagonal, mm</b>	4913 + 2769
<b>Number of windows</b>	5
<b>Number of opening windows</b>	3
<b>Number of benches</b>	6
<b>Number of folding benches</b>	2
<b>Weight, kg</b>	1700
<b>Number of persons</b>	12-15
<b>Size of windows, mm</b>	880 x 510
<b>Size of doors, mm</b>	780 x 1500

## Standard set

- Wall, floor panels;
- Insulated roof panels over the sauna room;
- Roof covered with bitumen shingles of your selected color;
- Inside grill with the cooking platforms and a table around the grill;
- Adjustable chimney;
- 5 double glass windows (3 of them are opening);
- Doors with a lock and a hexagon window;
- Inside glass doors between a grill room and a sauna room;
- 6 grill room benches (2 of them are folding benches);
- Cushions for the benches;
- Sauna benches;
- Heat - resistant plates for the stove/heater;
- Extension's size: 2.54 x 1.69 m.

## OPTIONS

- Roof shingles' color: red, black, green;
- 3 types of grill and chimney KITS;
- 6 types of heater and chimney KITS;
- Cushions' color: blue or brown;
- Possibility to make more opening windows or higher walls;
- Grill Cabin without a grill is available;
- Additional products can be found on page 5.

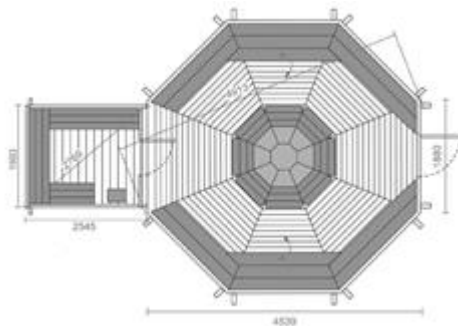

# Windows and doors

Window's size is 880 x 510 mm, door's size 780 x 1500 mm. Double glass units are used; The windows ensure lower heat transfer to the outside, a lot of light coming inside, and long usage time.

## Type of wood

### SPRUCE



We mainly use Nordic spruce, which comes from Scandinavia. The light, golden-white softwood radiates a friendly warmth. Every single board used for our Grill Cabin has its own individual character and history, and this makes our Cabin a real natural and unique product.

## Grill and chimney KITS

### STANDARD GRILL AND CHIMNEY KIT

Standard set: Grill with the cooking platforms and a table around the grill; Adjustable chimney. Total height of the 8 corners grill chimney is 220 cm. Grill height till table is 70 cm.

The grill is produced from 2 mm cold rolled steel sheets and welded using TIG type welding and the chimney is produced from 1 mm steel using spot-welding technique. All surfaces are painted using a powder coating. Powder paints can withstand 200 degrees (not direct flames).

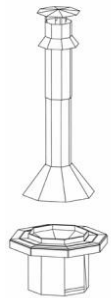

### „VIKING“ GRILL AND CHIMNEY KIT

Standard set: Grill with the cooking platforms and a table around the grill; Adjustable chimney. Total height of the chimney is 206 cm. Grill height till table is 62 cm.

All surfaces are painted using a powder coating. The powder paint is marked to withstand 550 degrees (not direct flames).



### „LUXURY“ GRILL AND CHIMNEY KIT

Standard set: Grill with the cooking platforms and a table around the grill; Adjustable chimney. Total height of the chimney is 250 cm. Grill height till table is 75 cm.

All surfaces are painted using a powder coating. The powder paint is marked to withstand 400 degrees (not direct flames). „Luxury“ grill and chimney KIT does not need to be attached to the walls with the chains.

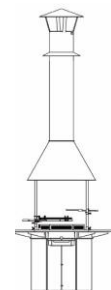

## Heater and chimney KITS

### ELECTRIC HEATER HARVIA ASSA, 6KW 400V

Reliable and affordable basic stove. Harvia Assa is a traditional wall-mounted heater with the best price and quality. The operating switches are placed at the bottom of the stove. Heater is a stylish black color. Stones and 400V connection included. The recommended size of the sauna room is 5–8 m<sup>3</sup>.



### WOODBURNING STOVE „HARVIA M3“ 16.5KW

A stylish stove for the smaller saunas. The Harvia M3 has a classic design and is suitable for the smaller wood burning saunas. A recommended size of the sauna room is 4.5–13 m<sup>3</sup>. Stones and standard chimney KIT included.



### WOODBURNING STOVE „HARVIA M3 SL“ 16.5KW)

The SL model (outside firewood feeding) is designed for people who want to conveniently heat their sauna from an outside. Stones and standard chimney KIT included.



### STANDARD CHIMNEY KIT

A Standard chimney KIT is made from stainless steel. This Standard chimney can withstand 450 degrees gas. Its outer diameters is 20 cm, and inner diameter is 11.5 cm.



### „LUXURY“ CHIMNEY KIT

A „Luxury“ chimney KIT is CE marked (under 1856-1 EN European Standardization Certificate). It is made from shiny stainless steel. It either use AISI 316 and/or AISI 304 as standards and insulation. This „Luxury“ chimney can withstand 600 degrees gas. Its outer diameters is 17 cm, and inner diameter is 11.5 cm.



## Roof shingles

### BITUMEN SHINGLES

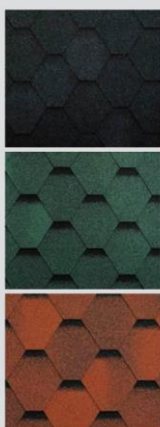

6 layer bitumen shingles are made from a durable and highly resistant fiber glass base coated with the polymer-reinforced bitumen mix which includes a high quality bitumen and an aggregate. The top layer of the shingles is covered with mineral granules ensuring the protection from UV as well as from other weather conditions. The granules are painted using a thermal method, which means that a pigment is burned-in into the surface of granules and this guarantees a long durability of the color. The bottom of the shingles is an adhesive polymer-reinforced bitumen layer protected with an easily removable silicon membrane. Due to the sun heat the overlapped tiles on the top stick to each other thus forming a double hydro-insulating layer which guarantees an excellent leak resistance of the roof. A color of the roof shingles can be chosen from black, green or red. A warranty term for the shingles is 15 years!



# Accessories



**flower pot**

Flower pot should be placed under the windows. Size of the pot: 107 x 21 x 16 cm.



**drawer**

Drawer should be placed under the benches. Is suitable for all grill cabins and pavilions that have benches. Size of drawer: 56 x 37 x 24 cm.



**reindeer hide**

Natural reindeer hides. Country of origin - Finland. Size of the reindeer hides: 120 - 130 cm length.



**safety fence**

Grill table's safety fence for a 8-corners grill. A solid steel fence provides better grill table protection from fire sparks.



**grill cover**

Grill cover 8-corners. Grill cover is made from spruce. It covers the grill so that you can use the fireplace as a table.



**Shelf**

Corner shelves is a great place to keep your things and the walls look less empty. Size: 74 x 30 cm.



**wooden ladle**

Wooden ladle is great for sprinkling water on the stones to create a sauna steam.



**headrest**

The elegantly designed head rest is a beautiful touch for your sauna.



**sauna light**

Protection level IP44. Bulb E14 (max. 40 W) is not included in the delivery.



**sauna light cover**

Beautiful wooden sauna light cover.



**Thermometer - hydrometer**

Thermometer - hydrometer helps you to keep an eye on both the sauna temperature and air humidity.



**back rest**

Back rest helps to sit more comfortably in the sauna. Alder or aspen wood.



**clothes hanger**

An excellent wall mounted solution for hanging towels. It is made from durable wood.



**wooden bucket**

Our wooden buckets have the plastic inner part, which prolongs product life and are easy to clean.



**22 liters water tank**

The water tank for quickly water heats up is mounted directly above the heater.



**wood burning heater safety fence**

Made from aspen or alder wood. It allows to keep a safety distances from hot wood burning heaters.



**electric ovens safety fence**

Made from aspen or alder wood. It allows to keep a safety distances from hot wood burning heaters.



**Sauna hats**

Sauna hats made from 100% wool (800 g/m<sup>2</sup>) with a place for your picture, logo or phrase.



# Transportation

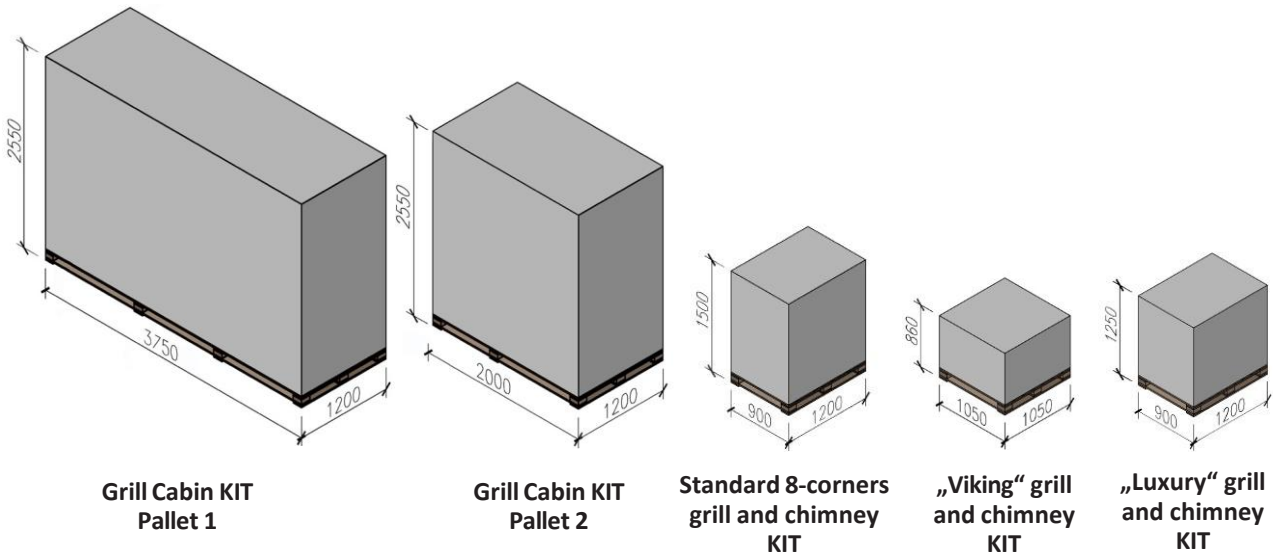

Grill Cabin is delivered to a customer not assembled (packed on a pallet (KIT)) but fully complete. Assembly instruction of Grill Cabin you can download and print from [www.hotbarrel.co.uk](http://www.hotbarrel.co.uk). Standard grill is packed with the Grill Cabin together but we strongly recommend to choose packing on a separate pallet. „Luxury“ and „Viking“ grills are packed only on the separate pallets. Grill Cabin KIT weight is **2150 kg**; Standard 8-corners grill and chimney KIT - **98 kg**; „Viking“ grill and chimney KIT - **96 kg**; „Luxury“ grill and chimney KIT - **96 kg**.

# Foundation

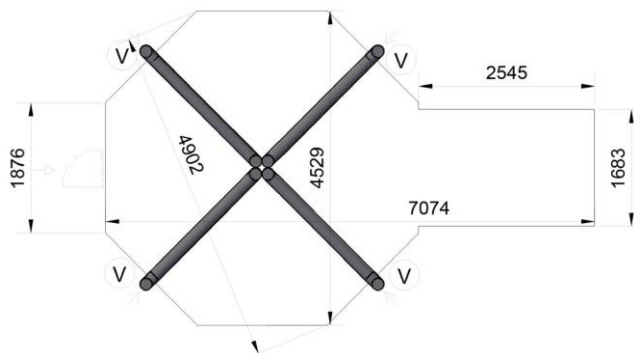
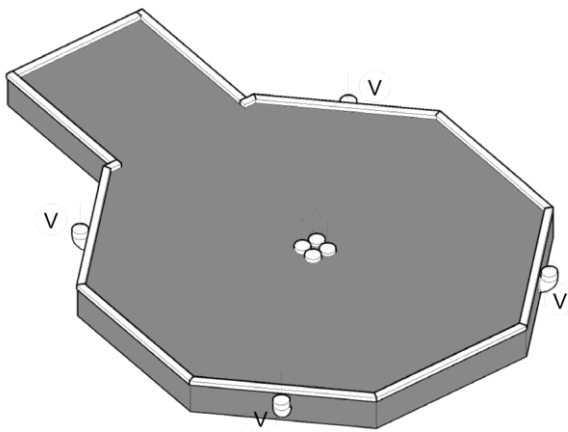

It is very important to have a proper foundation for your Grill Cabin. Therefore we recommend making the foundation according to the sketches here. First of all, foundation must be prepared according to the landscape and ground conditions. Consult a qualified builder or an engineer to prepare a proper foundation, which fits your location. Make sure to complete the site preparation and the foundation before unpacking and assembling the Grill Cabin.

Also in order to avoid a smoke in the Grill Cabin we strongly recommend installing 100-120 mm diameter ventilation pipes on 2 or 4 different foundation sides. Please note that these ventilation pipes must be covered so that no rain, leaves or anything else get there.



## Grill usage

While using the grill for the first time a smoky smell may appear. We advise to keep the door open and not to cook until the smell has cleared. Some splitting and burning of the grill paint is normal.

Please note, that the grill has sharp edges and the steel parts of the grill heat up while using it, therefore there are risks to harm yourself or get burned. Make sure to be careful.

We suggest using the starter cubes or a little bit of a lighter fluid and small dry birch logs for starting the fire. To do it easier, ensure that the grill is getting enough air, so keep the door open. The bigger logs can be added to the fire when it's already burning well. Choose a non-sparking

wood; avoid using spruce or aspen and a wood covered with the bark. We advise to use logs with max length of 300 mm and DO NOT use the coal briquettes.

A fresh air flow is the most important aspect to avoid the smoke, so make sure that there is enough of fresh air coming in. If the Grill Cabin is full of smoke, open the door of the Cabin and make sure that the wood you use for the fire is dry and not covered with the bark. Provide additional dry wood if needed.

Remove the coals and ashes from the grill after they have cooled down.

## Sauna usage

Saunas typically take 30-40 minutes to heat up. The recommended temperature is 80-90° C. The thermometer should be located at head level in the sauna. It should be located away from the heater or the door so it will not give a false reading.

Enjoy the many health benefits of relaxing heat in your own Sauna room just remember that staying in the hot Sauna for long periods of time makes the body temperature rise, which may be dangerous. The recommended time inside a Sauna room is from 10 to 15 minutes. Take a five-minute break and then repeat. Also you should keep safety instructions and keep away from the stove when it is hot. Never throw water on the stones when there are

people near the stove, because hot steam may burn their skin. Be very careful when moving in the Sauna, as the benches and floors may be slippery. Do not hang clothes to dry in the Sauna, as this may cause a risk of fire.

Also check your body for any metal (jewelry and zippers, for example) in order to prevent it from burning your body when it quickly heats up in the facility.

We strongly recommend shouldn't use the Sauna to pregnant women and neither should young children.

## Maintenance

As wood is a natural material, it can change through time. Cracks of various sizes, changes of the color as well as of a structure of the wood are not the errors, but a feature of wood.

Natural wood (not impregnated) becomes grayish after having been left untouched for a while. Later it can turn blue and get covered with the mold. Therefore, you should immediately impregnate the wood to protect the products.

We strongly recommend that you impregnate the door and windows with a wood impregnation agent both the inside and outside of them, because the doors and windows can become twisted otherwise. In general, we

recommend consulting a specialist regarding the paints suitable for an unprocessed softwood and follow the instructions of paints' manufacturers. Proper painting of the Grill Cabin will extend its lifetime. Besides that, we suggest you thoroughly inspecting the Cabin every six months and checking if it needs re-painting or else.

It's NOT advisable to paint the Grill Cabin walls before Assembling it – this is best done when the Cabin has been already assembled and when the weather is fine. However, if you wish to paint some parts in different colors, this should be done before the Cabin is assembled.

